

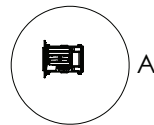



DETAIL A  
SCALE 1 : 2



1	1	Rev.	tolerance DIN ISO 2768/m				 post@cody.no www.cody.no This drawing belongs to cody as and can not be copied, changed or used without our prior permission.			
			Material							
1	1	Change	Date:	26.11.2013	Drawn by:	BHA		Approved by:		Scale
1	1	Date/sign.	Description:				This replaces drawing nr:		Reference	
			Ladder closed				-			
							Drawing nr:		Ladder-0913-assy-closed	

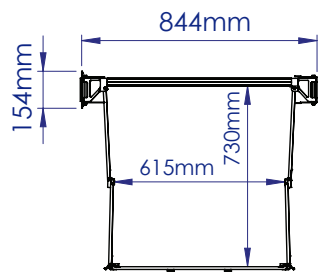
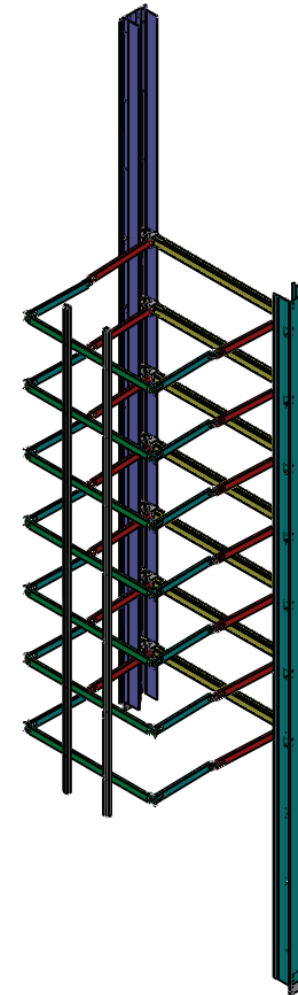
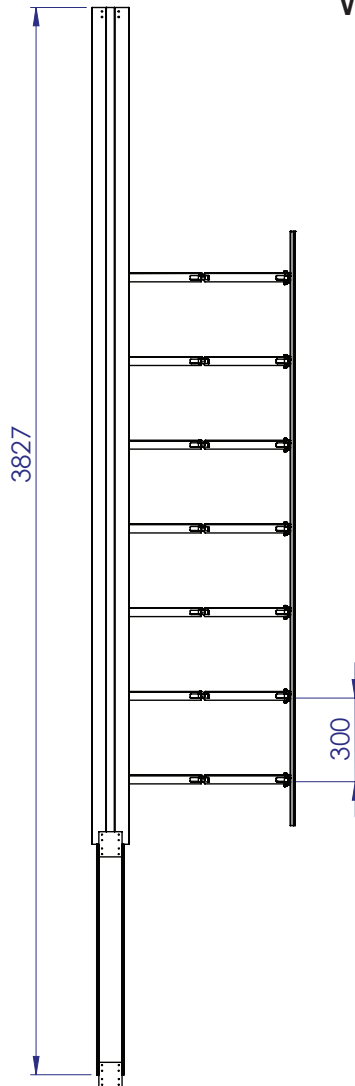
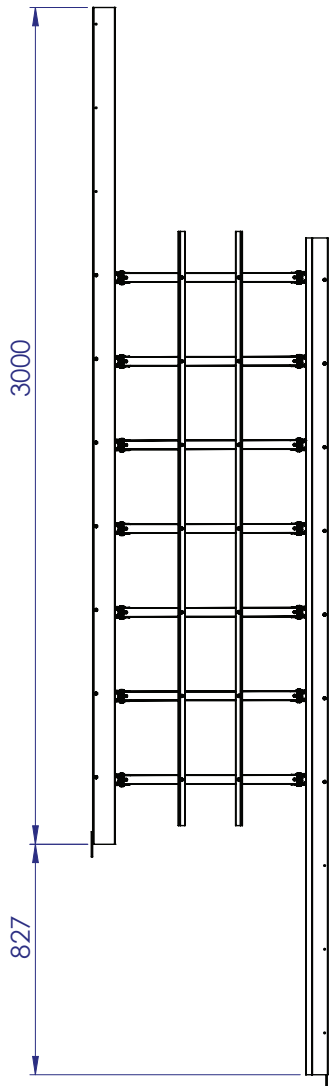

1	1	Rev.	tolerance DIN ISO 2768/m				 post@cody.no www.cody.no	
		Change	Material					This drawing belongs to cody as and can not be copied, changed or used without our prior permission.
		Date:	26.11.2013	Drawn by:	BHA	Approved by:		
						Scale	A3 1:20	
1	1	Date/sign.	Description:				This replaces drawing nr:	Reference
			Ladder open.				-	
							Drawing nr:	Ladder-0913-assy